

---

## EM-07-DIN and EM-07-60D-DIN,EM-07-100D-DIN,EM-07-250D-DIN USER MANUAL



- \* RS485 Modbus RTU (1200 - 38400bps)
- \* 53 x 31 Custom Design Glass LCD
- \* 3-phase voltage and 3-phase current transformer.
- \* It shows that V1, V2, V3, V12, V23, V31, I1, I2, I3, S1, S2, S3, F1, F2, F3
- \* It shows the minimum, maximum and average values of V1, V2, V3, V12, V23, V31, F1, F2, F3
- \* It shows the minimum, maximum, average and demand values of I1, I2, I3, S1, S2, S3
- \* High/Low voltage, current, frequency (adjustable)
- \* Phase-Neutral or Phase-Phase protection (adjustable)
- \* 1x relay output
- \* Protect Voltage, Current and Frequency
- \* Shows phase sequence
- \* You can delete the demands
- \* Menu is password-protected.

1 - Connection Diagrams:

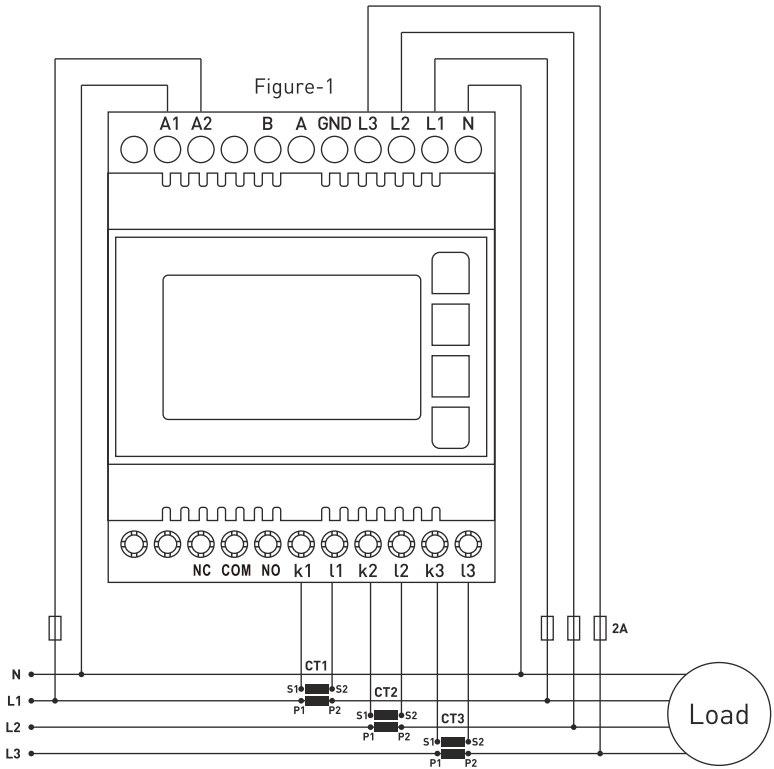

**Figure-1:** 3P4W connection type: 3 phase current and 3 phase voltage and neutral.

## 2 - Points to take into consideration in the selection and connection of Current Transformer: \_\_\_\_\_

- Be sure that the current transformer value is higher than the maximum current drawn from the system.
- In order to prevent any mistake while connecting the output terminals of the current transformer, use cables in different colors for each phase or designate a number for each cable.
- Keep the cables connected to the output terminals of the current transformer away from the high-voltage line.
- In order to prevent any shake on the current transformer, fix it on the bus-bar, cable or rail.

## 3 - Warnings: \_\_\_\_\_

- Use the device according to the instructions specified by us.
- Do not expose the LCD display directly to sunlight in order to avoid any harm on it.
- Note that the temperature level on the panel to which the device is mounted is at the range of operating temperature of the device (-20°C.....55°C)
- There must be a space of 5cm behind the device after its installation.
- Fix the device securely to the front-cover of the panel with the apparatus delivered together with the device.
- Be sure that the panel to which the device is mounted does not operate in a humid environment.
- Place the switch or circuit breaker close to the device or in a location that is easily accessible for the operator.
- Place a switch or circuit breaker on the system during installation of the device.
- Please note that the cables must not be energized during installation.
- Flexible monitored and twisted cables must be used for the input and output lines which are not connected to the mains.
- The technical personnel according with the instructions specified in the user's manual must perform installation of the device and electrical connections.
- The feeder cables must be compatible with the requirements of IEC 60227 or IEC 60245

## 4 - Maintenance of the Device: \_\_\_\_\_

De-energize and disconnect the device. Clean the body of the device with a dry or damp-dry cloth. Do not use conductive or other chemical substances as a cleaning agent that can damage the device. After cleaning the device, make its connections and check whether it is working by energizing it.

## 5 - General: \_\_\_\_\_

EM-07-DIN Multimeter measures the load on the system and voltage, current, apparent power minimum and maximum values, demands related to this load on the system.

## 6- Introduction of Home Screen:

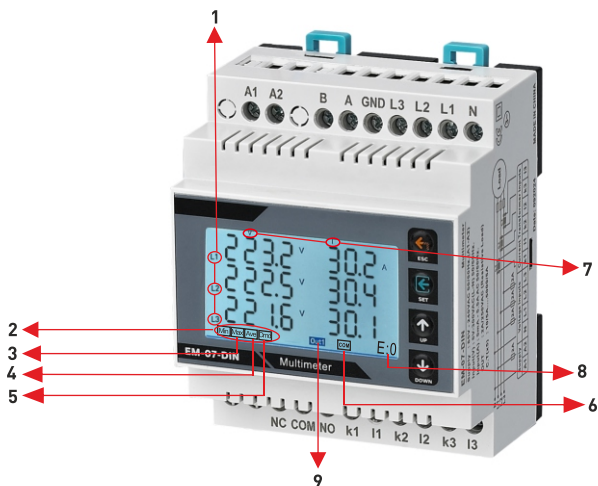







Figure-2

- 1 - It shows phase number belong to measurement values
- 2 - Showing values are minimum of measurement values
- 3 - Showing values are maximum of measurement values
- 4 - Showing values are average of measurement values
- 5 - Showing values are demand of measurement values
- 6 - It shows Serial Communications
- 7 - It shows that type of measurement values
- 8 - It shows number of error
- 9 - It shows relay state.  means that relay is close,  means that relay is open.

## 7- Definition of Buttons:

-  **ESC:** State of Measurement; Back to home screen. State of Menu; Exit menu. State of changing parameter; Not save chance and back to menu state. State of Error; Manual reset
-  **SET:** State of Measurement; Entry Menu. State of Menu; Entry state of changing parameter. State of changing parameter; save chance and back to menu state
-  **UP:** State of Measurement; To navigate from a main measurement values to another. State of Menu; To navigate from menu parameters to another. State of changing parameter; Increase value of parameter
-  **DOWN:** State of Measurement; To navigate from a deep measurement values to another (min,max,avg, dmd). State of Menu; To navigate from menu parameters to another. State of changing parameter; Decrease value of parameter

## 8- Error Codes:

If device in any case of error cut off, Relay will be open, backlight of display will be flashing and bottom right-hand corner of display will display ERR Code.

Error Code	Information
E:0	Phase Sequence ERR
E:1	High Voltage ERR
E:2	Low Voltage ERR
E:3	High Current ERR
E:4	Low Current ERR
E:5	High Frequency ERR
E:6	Low Frequency ERR
E:7	Demurrage ERR
E:8	Voltage Fuses ERR
E:9	Current Fuses ERR
E:A	Asymmetry Voltage ERR
E:b	Asymmetry Current ERR

## 9 - Start-up of the Device:

Read the warnings before the device is energized. Make sure that the device is connected according to the connection diagram. When the device energized for the first time, the Home Screen is displayed. Enter the current transformer ratio and the voltage transformer ratios\*, if installed, on the settings menu at first.  
\*: Only on EM-07-DIN.

## 10 - Display Information:



Home Screen

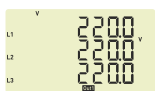

Figure-3



Figure-4



Figure-5

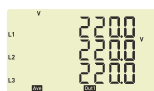

Figure-6

**Home Screen:** It shows voltage and current values together. If protection type is L-N, it shows phase-neutral voltage else, if protection type is L-L it shows phase-phase voltage. If you use voltage transformer, it is not showed. The figure-3 is displayed when you press the Down button.

**Figure-3:** It shows the phase-neutral voltage values. The figure-4 is displayed when you press the Down button.

**Figure-4:** It shows the phase-neutral minimum voltage values. The figure-5 is displayed when you press the Down button.

**Figure-5:** It shows the phase-neutral maximum voltage values. The figure-6 is displayed when you press the Down button.

**Figure-6:** It shows the phase-neutral mean voltage values. The figure-7 is displayed when you press the Down button.



Figure-7



Figure-8



Figure-9



Figure-10

**Figure-7:** It shows the phase- phase voltage values. The figure-8 is displayed when you press the Down button.

**Figure-8:** It shows the phase- phase minimum voltage values. The figure-9 is displayed when you press the Down button.

**Figure-9:** It shows the phase- phase maximum voltage values. The figure-10 is displayed when you press the Down button.

**Figure-10:** It shows the phase- phase mean voltage values. The figure-11 is displayed when you press the Down button.



Figure-11



Figure-12



Figure-13



Figure-14



Figure-15

**Figure-11:** It shows the current values of each phase. The figure-12 is displayed when you press the Down button.

**Figure-12:** It shows the minimum current values of each phase. The figure-13 is displayed when you press the Down button.

**Figure-13:** It shows the maximum current values of each phase. The figure-14 is displayed when you press the Down button.

**Figure-14:** It shows the mean current values of each phase. The figure-15 is displayed when you press the Down button.

**Figure-15:** It shows the current demand current values of each phase. The figure-16 is displayed when you press the Down button.



Figure-16



Figure-17



Figure-18



Figure-19



Şekil-20

**Figure-16:** It shows the apparent power values of each phase. The figure-17 is displayed when you press the Down button.

**Figure-17:** It shows the minimum apparent power values of each phase. The figure-18 is displayed when you press the Down button.

**Figure-18:** It shows the maximum apparent power values of each phase. The figure-19 is displayed when you press the Down button.

**Figure-19:** It shows the mean apparent power values of each phase. The figure-20 is displayed when you press the Down button.

**Figure-20:** It shows the apparent power demand values of each phase. The figure-21 is displayed when you press the Down button.



Figure-21



Figure-22



Figure-23



Figure-24

**Figure-21:** It shows the frequency values of each phase. The figure-22 is displayed when you press the Down button.

**Figure-22:** It shows the minimum frequency values of each phase. The figure-23 is displayed when you press the Down button.

**Figure-23:** It shows the maximum frequency values of each phase. The figure-24 is displayed when you press the Down button.

**Figure-24:** It shows the mean frequency values of each phase. The Home Screen is displayed when you press the Down button.

## 11 - To advance in Display Inventory:

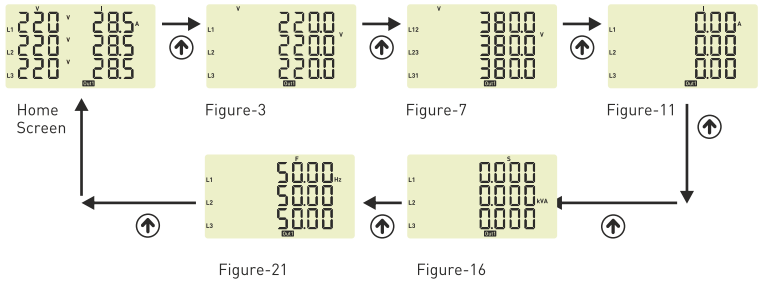

The Home screen is displayed, when the device is energized. When you press the up button to see the other data on the display, the next data is displayed (Figure-3). The figure-7 is displayed when you press the Up button. The figure-11 is displayed when you press the Up button. The figure-16 is displayed when you press the Up button. The figure-21 is displayed when you press the Up button. The screen back to Home Screen when you press the Up button.

If you want to see values of min,max,mean and demand you can use down button. If you back to home screen in anywhere, you can use ESC button.

## 12 - Settings:

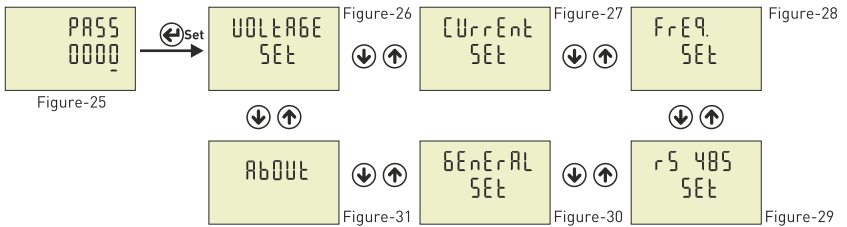

**Figure-25:** Press Menu button to enter password section. The figure-26 is displayed when you enter password and press the Menu button.

**Figure-26:** It uses for voltage settings. The figure-27 is displayed when you press the UP button.

**Figure-27:** It uses for current settings. The figure-28 is displayed when you press the UP button.

**Figure-28:** It uses for frequency settings. The figure-29 is displayed when you press the UP button.

**Figure-29:** It uses for RS-485 settings. The figure-30 is displayed when you press the UP button.

**Figure-30:** It uses for general settings. The figure-31 is displayed when you press the UP button.

**Figure-31:** It uses for about the device. This section give a information about device serial number and version number. You can use ESC button for exit menu.

### 13.1 - Voltage Settings:

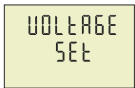

Figure-26

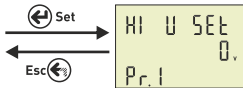

Figure-32

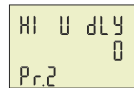

Figure-33

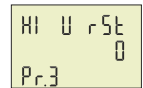

Figure-34

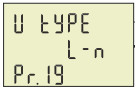

Figure-50

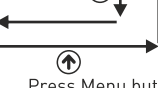

Figure-32

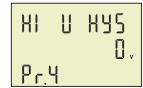

Figure-35

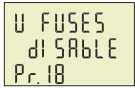

Figure-49

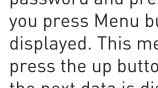

Figure-32

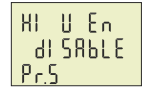

Figure-36

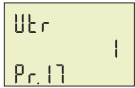

Figure-48

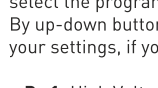

Figure-32

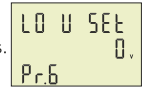

Figure-37

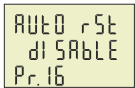

Figure-47

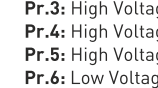

Figure-32

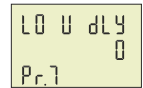

Figure-38

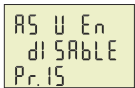

Figure-46

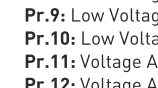

Figure-32

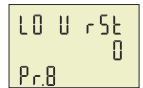

Figure-39

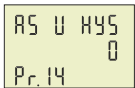

Figure-45

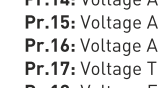

Figure-32

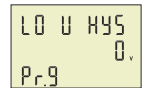

Figure-40

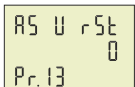

Figure-44

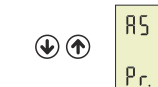

Figure-32

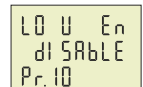

Figure-41

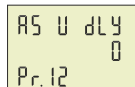

Figure-43

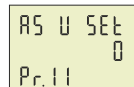

Figure-42

Press Menu button and enter password (Default Password =0000) to enter program list. The figure-26 is displayed when you enter password and press the Menu button. You enter Voltage set when you press Menu button. If you enter voltage set menu, the figure-32 is displayed. This menu have 19 different voltage set value. When you press the up button to see the other voltage set values on the display, the next data is displayed. The figure-32 is displayed when you press the up button after the Pr.19 is displayed. By using up-down buttons select the program. Press Menu to enter required program. By up-down buttons, you can set the program. Press Menu to record your settings, if you press ESC button, you cannot record your settings.

- Pr.1:** High Voltage Protection Value
- Pr.2:** High Voltage Protection Delay time
- Pr.3:** High Voltage Protection Reset time
- Pr.4:** High Voltage Protection Hysteresis
- Pr.5:** High Voltage Protection Enable/Disable
- Pr.6:** Low Voltage Protection Value
- Pr.7:** Low Voltage Protection Delay time
- Pr.8:** Low Voltage Protection Reset time
- Pr.9:** Low Voltage Protection Hysteresis
- Pr.10:** Low Voltage Protection Enable/Disable
- Pr.11:** Voltage Asymmetry Protection Value
- Pr.12:** Voltage Asymmetry Protection Delay Time
- Pr.13:** Voltage Asymmetry Protection Reset Time
- Pr.14:** Voltage Asymmetry Protection Hysteresis
- Pr.15:** Voltage Asymmetry Protection Enable/Disable
- Pr.16:** Voltage Auto Reset Enable/Disable
- Pr.17:** Voltage Transformer Ratio
- Pr.18:** Voltage Fuses Enable/Disable
- Pr.19:** Voltage Protection Type

```
HI U SEt
Pr.1      0.
```

Figure-32

**Pr.1 : High Voltage Protection Value:** Determines the maximum operating voltage value of load.

**Default:** 250V, **Min:** 1V, **Max:** 300V

```
HI U dLY
Pr.2      0
```

Figure-33

**Pr.2: High Voltage Protection Delay Time:** Determines delay open time. Delay time for activating the output. If any voltage exceeds high voltage protect value, Relay output switches open at the end of delay time.

**Default:** 3sec, **Min:** 1sec, **Max:** 10000sec.

```
HI U rSt
Pr.3      0
```

Figure-34

**Pr.3: High Voltage Protection Reset Time:** Determines delay close time. If all voltage below the high voltage protect value as a hysteresis voltage , relay output switches close at the end of the reset time.

**Default:** 3sec, **Min:** 1sec, **Max:** 10000sec.

```
HI U HYS
Pr.4      0.
```

Figure-35

**Pr.4: High Voltage Protection Hysteresis:** Required hysteresis voltage for high voltage warning is programmed.

**Default:** 5V, **Min:** 1V, **Max:** 200V

```
HI U En
dI SAbLE
Pr.5      0.
```

Figure-36

**Pr.5: High Voltage Protection Enable/Disable:** Determines Enable or Disable the high voltage protection.

**Default:** Enable, **Min:** Disable, **Max:** Enable

```
LO U SEt
Pr.6      0.
```

Figure-37

**Pr.6: Low Voltage Protection Value:** Determines the minimum operating voltage value of load.

**Default:** 170V, **Min:** 1V, **Max:** 300V

```
LO U dLY
Pr.7      0
```

Figure-38

**Pr.7: Low Voltage Protection Delay Time :** Determines delay open time. Delay time for activating the output. If any voltage over the low voltage protect value, Relay output switches open at the end of delay time.

**Default:** 3sec, **Min:** 1sec, **Max:** 10000sec.

```
LO U rSt
Pr.8      0
```

Figure-39

**Pr.8: Low Voltage Protection Reset Time:** Determines delay close time.If all voltage below the low voltage protect value as a hysteresis voltage , relay output switches close at the end of the reset time.

**Default:** 3sec, **Min:** 1sec, **Max:** 10000sec.

```
LO U HYS
Pr.9      0.
```

Figure-40

**Pr.9: Low Voltage Protection Hysteresis:** Required hysteresis voltage for low voltage warning is programmed.

**Default:** 5V, **Min:** 1V, **Max:** 200V

```
LO U En
dI SAbLE
Pr.10     0
```

Figure-41

**Pr.10: Low Voltage Protection Enable/Disable:** Determines Enable or Disable the low voltage protection.

**Default:** Enable, **Min:** Disable, **Max:** Enable

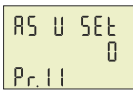

AS U SEt 0  
Pr.11

Figure-42

**Pr.11: Voltage Asymmetry Protection Value :** Determines the controlled voltage asymmetry. **Asymmetry Ratio Adjustment:** Device calculates a value by dividing difference between highest and lowest phase value to highest phase value.

**Asymmetry Ratio** =  $[(\text{Highest Voltage} - \text{Lowest Voltage}) / \text{Highest Voltage}] \times 100$   
**Default:** %20, **Min:** %5, **Max:** %30

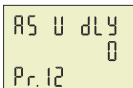

AS U dLY 0  
Pr.12

Figure-43

**Pr.12: Voltage Asymmetry Protection Delay time:** Determines delay open time. Delay time for activating the output. If calculated asymmetry value below the voltage asymmetry protect value, Relay output switches open at the end of delay time.

**Default:** 3sec, **Min:** 1sec, **Max:** 10000sec.

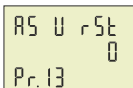

AS U rSt 0  
Pr.13

Figure-44

**Pr.13: Voltage Asymmetry Protection Reset Time:** Determines delay close time.

If calculated asymmetry value over the voltage asymmetry protect value as a hysteresis voltage, relay output switches close at the end of the reset time.

**Default:** 3sec, **Min:** 1sec, **Max:** 10000sec.

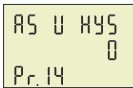

AS U HYS 0  
Pr.14

Figure-45

**Pr.14: Voltage Asymmetry Protection Hysteresis:** Required hysteresis voltage for voltage asymmetry warning is programmed.

**Default:** %2, **Min:** %1, **Max:** %10

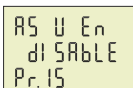

AS U En  
dI SAbLE  
Pr.15

Figure-46

**Pr.15: Voltage Asymmetry Protection Enable/Disable:** Determines Enable or Disable the voltage asymmetry protection.

**Default:** Enable, **Min:** Disable, **Max:** Enable

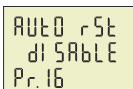

AUtO rSt  
dI SAbLE  
Pr.16

Figure-47

**Pr.16: Voltage Auto Reset Enable/Disable:** If auto reset enable and system into error, if all voltage are over/below the protect value as hysteresis value, relay output switches on at the end of the Reset time. If Auto reset is disable, after all voltage are over/below hysteresis value, relay output switches manually. (Using ESC button).

**Default:** Enable, **Min:** Disable, **Max:** Enable

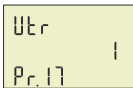

UTr 1  
Pr.17

Figure-48

**Pr.17: Voltage Transformer Ratio:** If you use medium voltage, you can use VTR

**Default:** 1, **Min:** 1, **Max:** 999



U FUSEs  
dI SAbLE  
Pr.18

Figure-49

**Pr.18: Voltage Fuses Enable/Disable:** If any phase voltage exceeds 1.5 times of high voltage protect values, or, if any phase voltage decrease 0.5 times of low voltage protect value, the relay switches off instantly. At position disable, voltage fuses function is cancelled.

**Default:** Disable, **Min:** Disable, **Max:** Enable

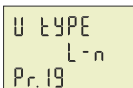

U tYPE  
L-n  
Pr.19

Figure-50

**Pr.19: Voltage Protection Type:** Voltage Protection can be selected as L-N or L-L in this menu. Phase-Neutral voltage protection can be implemented if the "L-N" protection is selected. Phase-Phase voltage protection can be implemented if the "L-L" protection is selected.

**Default:** L-n, **Min:** L-n, **Max:** L-L

## 13.2 - Current Settings:

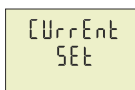

Figure-27

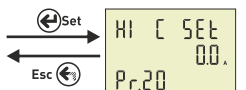

Figure-51

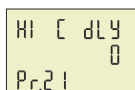

Figure-52

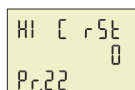

Figure-53

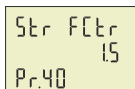

Figure-71

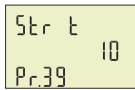

Figure-70

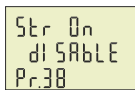

Figure-69



Figure-68

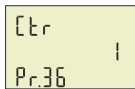

Figure-67

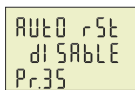

Figure-66

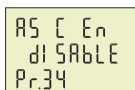

Figure-65

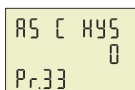

Figure-64

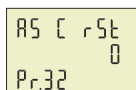

Figure-63

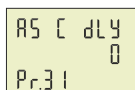

Figure-62

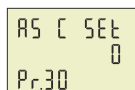

Figure-61

Press Menu button and enter password (Default Password =0000) to enter program list. The figure-26(Voltage SET) is displayed when you enter password and press the Menu button. The figure-27 (Current SET) is displayed when you press the up button. You enter Current set when you press Menu button. If you enter Current set menu, the figure-51(Pr.20) displayed. This menu have 21 different current set value. When you press the up button to see the other current set values on the display, the next data is displayed. The figure-51 is displayed when you press the up button after the Pr.40 is displayed. By using up-down buttons select the program. Press Menu to enter required program. By up-down buttons, you can set the program. Press Menu to record your settings, if you press ESC button, you cannot record your settings.

**Pr.20:** High Current Protection Value

**Pr.21:** High Current Protection Delay Time

**Pr.22:** High Current Protection Reset Time

**Pr.23:** High Current Protection Hysteresis

**Pr.24:** High Current Protection Enable/Disable

**Pr.25:** Low Current Protection Value

**Pr.26:** Low Current Protection Delay Time

**Pr.27:** Low Current Protection Reset Time

**Pr.28:** Low Current Protection Hysteresis

**Pr.29:** Low Current Protection Enable/Disable

**Pr.30:** Current Asymmetry Protection Value

**Pr.31:** Current Asymmetry Protection Delay Time

**Pr.32:** Current Asymmetry Protection Reset Time

**Pr.33:** Current Asymmetry Protection Hysteresis

**Pr.34:** Current Asymmetry Protection Enable/Disable

**Pr.35:** Current Auto Reset Enable/Disable

**Pr.36:** Current Transformer Ratio \*

**Pr.37:** Current Fuses Enable/Disable

**Pr.38:** Demurrage Protection Enable/Disable

**Pr.39:** Demurrage Protection Time

**Pr.40:** Demurrage Protection Factor

\*: Only on EM-07.

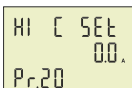

HI C SEt  
00.  
Pr20

Figure-51

**Pr.20: High Current Protection Value:** Determines the maximum operating current value of load.

**Default:** 3.0A, **Min:** 0.1A, **Max:** 5.0A

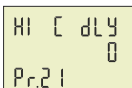

HI C dLY  
0  
Pr21

Figure-52

**Pr.21: High Current Protection Delay Time:** Determines delay open time. Delay time for activating the output. If any current exceeds high current protect value, Relay output switches open at the end of delay time.

**Default:** 3sec, **Min:** 1sec, **Max:** 10000sec.

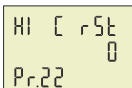

HI C rSt  
0  
Pr22

Figure-53

**Pr.22: High Current Protection Reset Time:** Determines delay close time. If all current below the high current protect value as a hysteresis current, relay output switches close at the end of the reset time.

**Default:** 10sec, **Min:** 1sec, **Max:** 10000sec.

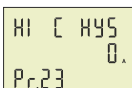

HI C HYS  
0.  
Pr23

Figure-54

**Pr.23: High Current Protection Hysteresis:** Required hysteresis current for high current warning is programmed.

**Default:** 0.5A, **Min:** 0.1A, **Max:** 3.0A

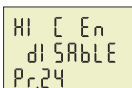

HI C En  
dI SAbLE  
Pr24

Figure-55

**Pr.24: High Current Protection Enable/Disable:** Determines Enable or Disable the high current protection.lir.

**Default:** Enable, **Min:** Disable, **Max:** Enable

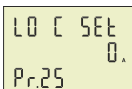

LO C SEt  
0.  
Pr25

Figure-56

**Pr.25: Low Current Protection Value:** Determines the minimum operating current value of load.

**Default:** 0.1A, **Min:** 0.1A, **Max:** 5.0A

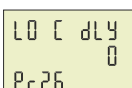

LO C dLY  
0  
Pr26

Figure-57

**Pr.26: Low Current Protection Delay Time:** Determines delay open time. Delay time for activating the output. If any current over the low current protect value, Relay output switches open at the end of delay time.

**Default:** 3sec, **Min:** 1sec, **Max:** 10000sec.

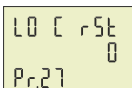

LO C rSt  
0  
Pr27

Figure-58

**Pr.27: Low Current Protection Reset Time:** Determines delay close time. If all current below the low current protect value as a hysteresis current, relay output switches close at the end of the reset time.

**Default:** 10sec, **Min:** 1sec, **Max:** 10000sec.

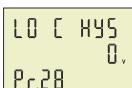

LO C HYS  
0.  
Pr28

Figure-59

**Pr.28: Low Current Protection Hysteresis:** Required hysteresis current for low voltage warning is programmed.

**Default:** 0.5A, **Min:** 0.1A, **Max:** 3.0A

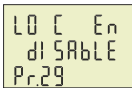

LO C En  
dI SAbLE  
Pr29

Figure-60

**Pr.29: Low Current Protection Enable/Disable:** Determines Enable or Disable the low current protection.

**Default:** Enable, **Min:** Disable, **Max:** Enable

```
AS [ SET
Pr30 0
```

Figure-61

**Pr.30: Current Asymmetry Protection Value:** Determines the controlled current asymmetry. **Asymmetry Ratio Adjustment:** Device calculates a value by dividing difference between highest and lowest phase value to highest phase value.

**Default:** %30, **Min:** %5, **Max:** %50

```
AS [ dLY
Pr31 0
```

Figure-62

**Pr.31: Current Asymmetry Protection Delay Time :** Determines delay open time. Delay time for activating the output. If calculated asymmetry value below the current asymmetry protect value, Relay output switches open at the end of delay time.

**Default:** 3sec, **Min:** 1sec, **Max:** 10000sec.

```
AS [ rSt
Pr32 0
```

Figure-63

**Pr.32: Current Asymmetry Protection Reset Time:** Determines delay close time. If calculated asymmetry value over the current asymmetry protect value as a hysteresis current, relay output switches close at the end of the reset time.

**Default:** 10sec, **Min:** 1sec, **Max:** 10000sec.

```
AS [ HYS
Pr33 0
```

Figure-64

**Pr.33: Current Asymmetry Protection Hysteresis:** Required hysteresis current for current asymmetry warning is programmed.

**Default:** %3, **Min:** %1, **Max:** %20

```
AS [ En
dISABLE
Pr34
```

Figure-65

**Pr.34: Current Asymmetry Protection Enable/Disable:** Determines Enable or Disable the current asymmetry protection.

**Default:** Disable, **Min:** Disable, **Max:** Enable

```
AUTO rSt
dISABLE
Pr35
```

Figure-66

**Pr.35: Current Auto Reset Enable/Disable :** If auto reset enable and system into error, if all current are over/below the protect value as hysteresis value ,relay output switches on at the end of the Reset time. If Auto reset is disable, after all current are over/below hysteresis value, relay output switches manually. (Using ESC button).

**Default:** Enable, **Min:** Disable, **Max:** Enable

```
CTr
Pr36 1
```

Figure-67

**Pr.36: Current Transformer Ratio:** If a current transformer which has a ratio of 100/5A is used between the system and device; Current transformer ratio is entered as =  $100/5 = 20$ . \*

**Default:** 1, **Min:** 1, **Max:** 2000

\*: Only on EM-07.

```
[ FUSES
dISABLE
Pr37
```

Figure-68

**Pr.37: Current Fuses Enable/Disable:** If any phase current exceeds 1.5 times of high current protect value, or ,if any phase current decrease 0.5 times of low voltage protect value, the relay switches off instantly. At position disable, current fuses function is cancelled.

**Default:** Disable, **Min:** Disable, **Max:** Enable

```
St r On
dISABLE
Pr38
```

Figure-69

**Pr.38: Demurrage Protection Enable/Disable:** Determines Enable or Disable the demurrage protection.

**Default:** Enable, **Min:** Disable, **Max:** Enable

```
St r t
Pr39 10
```

Figure-72

**Pr.39: Demurrage Protection Time:** Demurrage time is used to prevent from faulty switching caused by motor Demurrage current. In this period, demurrage is controlled by device.

**Default:** 10, **Min:** 1, **Max:** 100

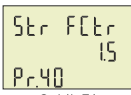

Şekil-71

**Pr.40: Demurrage Protection Factor:** Demurrage current is 3-5 times more than normal operation current consumption.

**Ex:** High current set value is :5A, demurrage protection factor is :1.5.

Max Demurrage current is  $5 \times 1.5 = 7.5$  A so device will let motor use 35A for start up.

**Default:** 3.0, **Min:** 1.0, **Max:** 10.0.

### 13.3 - Frequency Settings:

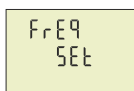

Figure-28

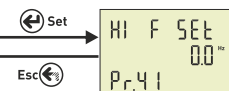

Figure-72

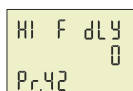

Figure-73

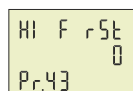

Figure-74

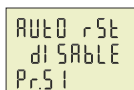

Figure-82

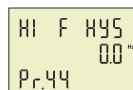

Figure-75

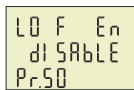

Figure-81

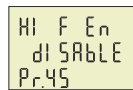

Figure-76

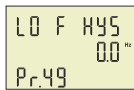

Figure-80

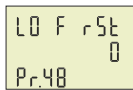

Figure-79

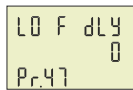

Figure-78

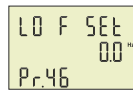

Figure-77

Press Menu button and enter password to enter program list. The figure-26(Voltage SET) is displayed when you enter password and press the Menu button. The figure-27(Current SET) is displayed when you press the up button. The figure-28(Frequency SET) is displayed when you press the up button. You enter Frequency set when you press Menu button. If you enter Frequency set menu, the figure-72(Pr.41) displayed. This menu have 11 different current set value. When you press the up button to see the other Frequency set values on the display, the next data is displayed. The figure-Figure 78 is displayed when you press the up button after the Pr.51 is displayed. By using up-down buttons select the program. Press Menu to enter required program. By up-down buttons, you can set the program. Press Menu to record your settings, if you press ESC button, you cannot record your settings.

**Pr.41:** High Frequency Protection Value

**Pr.42:** High Frequency Protection Delay Time

**Pr.43:** High Frequency Protection Reset Time

**Pr.44:** High Frequency Protection Hysteresis

**Pr.45:** High Frequency Protection Enable/Disable

**Pr.46:** Low Frequency Protection Value

**Pr.47:** Low Frequency Protection Delay Time

**Pr.48:** Low Frequency Protection Reset Time

**Pr.49:** Low Frequency Protection Hysteresis

**Pr.50:** Low Frequency Protection Enable/Disable

**Pr.51:** Frequency Auto Reset Enable/Disable

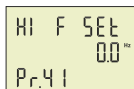
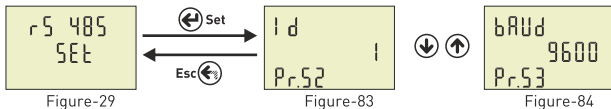

Figure-72

**Pr.41: High Frequency Protection Value :** Determines the maximum operating frequency value of load.

**Default:** 51Hz, **Min:** 45.0Hz, **Max:** 70.0Hz

### 13.4 - RS485 RS485 Settings:



Press Menu button and enter password to enter program list. The figure-26(Voltage SET) is displayed when you enter password and press the Menu button. The figure-27(Current SET) is displayed when you press the up button. The figure-28(Frequency SET) is displayed when you press the up button. The figure-29 (RS485 SET) is displayed when you press the up button. You enter Rs-485 set when you press Menu button. If you enter Rs-485 set menu, the figure-83(Pr.52) displayed. This menu have 2 different current set value. When you press the up button to see the other Frequency set values on the display, the next data is displayed. By using up-down buttons select the program. Press Menu to enter required program. By up-down buttons, you can set the program. Press Menu to record your settings, if you press ESC button, you cannot record your settings.

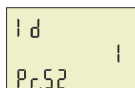

Figure-83

**Pr.52: Modbus ID:** Determines Modbus device ID.  
**Default: 1, Min: 1, Max: 247**

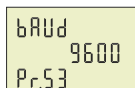
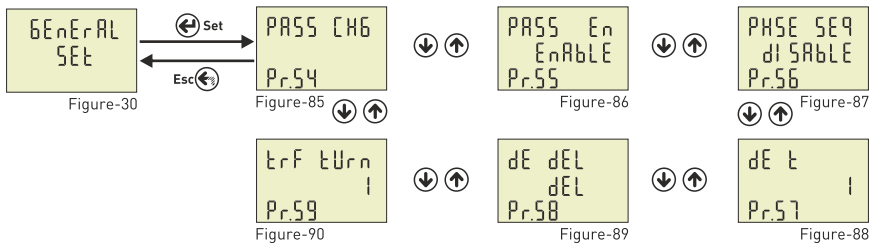

Figure-84

**Pr.53: Baudrate Selection:** Determines Modbus communication speed.  
**Default: 9600bps, Min: 1200bps, Max: 38400bps**

Note: **Stopbits: 1, Parity: none and Databits: 8**

### 13.5 - General Settings:



Press Menu button and enter password to enter program list. The figure-26(Voltage SET) is displayed when you enter password and press the Menu button. The figure-27(Current SET) is displayed when you press the up button. The figure-28(Frequency SET) is displayed when you press the up button. The figure-29 (RS485 SET) is displayed when you press the up button. The figure-30(General SET) is displayed when you press the up button. You enter General set when you press Menu button. If you enter General set menu, the figure-85(Pr.54) displayed. This menu have 6 different current set value. When you press the up button to see the other General set values on the display, the next data is displayed. By using up-down buttons select the program. Press Menu to enter required program. By up-down buttons, you can set the program. Press Menu to record your settings, if you press ESC button, you cannot record your settings.

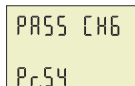
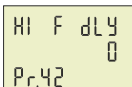

Figure-85

**Pr.54: Password Change:** This menu is used for changing the user password.  
**Default: 0000, Min: 0000, Max: 9999**



HI F dLY 0  
Pr.42

Figure-73

**Pr.42: High Frequency Protection Delay Time:** Determines delay open time. Delay time for activating the output. If any frequency exceeds high frequency protect value, Relay output switches open at the end of delay time.

**Default:** 3sec, **Min:** 1sec, **Max:** 10000sec.

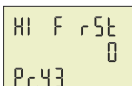

HI F rSt 0  
Pr.43

Figure-74

**Pr.43: High Frequency Protection Reset Time:** Determines delay close time. If all frequency below the high frequency protect value as a hysteresis frequency, relay output switches close at the end of the reset time.

**Default:** 3sec, **Min:** 1sec, **Max:** 10000sec.

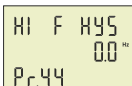

HI F HYS 0.0  
Pr.44

Figure-75

**Pr.44: High Frequency Protection Hysteresis:** Required hysteresis frequency for high frequency warning is programmed.

**Default:** 0.5Hz, **Min:** 0.1Hz, **Max:** 20.0Hz

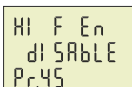

HI F En  
dI SAbLE  
Pr.45

Figure-76

**Pr.45: High Frequency Protection Enable/Disable:** Determines Enable or Disable the high frequency protection.

**Default:** Disable, **Min:** Disable, **Max:** Enable

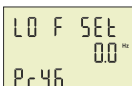

LO F SEt 0.0  
Pr.46

Figure-77

**Pr.46: Low Frequency Protection Value:** Determines the minimum operating frequency value of load.

**Default:** 49Hz, **Min:** 45.0Hz, **Max:** 70.0Hz

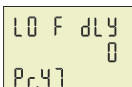

LO F dLY 0  
Pr.47

Figure-78

**Pr.47: Low Frequency Protection Delay Time:** Determines delay open time. Delay time for activating the output. If any frequency over the low frequency protect value, Relay output switches open at the end of delay time.

**Default:** 3sec, **Min:** 1sec, **Max:** 10000sec.

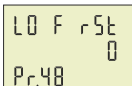

LO F rSt 0  
Pr.48

Figure-79

**Pr.48: Low Frequency Protection Reset Time:** Determines delay close time. If all frequency below the low frequency protect value as a hysteresis frequency, relay output switches close at the end of the reset time.

**Default:** 3sec, **Min:** 1sec, **Max:** 10000sec.

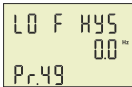

LO F HYS 0.0  
Pr.49

Figure-80

**Pr.49: Low Frequency Protection Hysteresis:** Required hysteresis frequency for low voltage warning is programmed.

**Default:** 0.5Hz, **Min:** 0.1Hz, **Max:** 20.0Hz

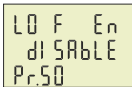

LO F En  
dI SAbLE  
Pr.50

Figure-81

**Pr.50: Low Frequency Protection Enable/Disable:** Determines Enable or Disable the low frequency protection.

**Default:** Disable, **Min:** Disable, **Max:** Enable

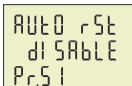

AUtO rSt  
dI SAbLE  
Pr.51

Figure-82

**Pr.51: Frequency Auto Reset Enable/Disable:** If auto reset enable and system into error, if all frequency are over/below the protect value as hysteresis value ,relay output switches on at the end of the Reset time. If Auto reset is disable, after all frequency are over/below hysteresis value, relay output switches manually. (Using ESC button).

**Default:** Disable, **Min:** Disable, **Max:** Enable

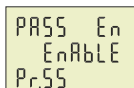

Figure-86

**Pr.55: Password Protection Enable/Disable**This menu is used for activating the user password. After the user password is activated for entering to the menus; if the Menu button is pressed, while the instant values are observed, user password is required.

**Default:** Disable, **Min:** Disable, **Max:** Enable

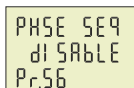

Figure-87

**Pr.56: Phase Sequence Protection Enable/Disable:** You can use device with phase sequence or without phase sequence function. If you set device for phase sequence, when running, it will be check phase sequence and it will display sequence error on screen. If you set "Disable" You can see phase sequence error but device not give error.

**Default:** Disable, **Min:** Disable, **Max:** Enable

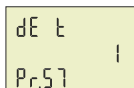

Figure-88

**Pr.57: Demand Time**Determines demand calculate time. Demand is calculated using average value. Device take sample for demand time and calculate average value. Demand is maximum average value.

**Default:** 15min, **Min:** 1min, **Max:** 120min.

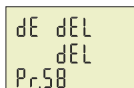

Figure-89

**Pr.58: Demand Record Delete:** You can delete demand and average records.

**If cut off device energy min,max, average and demand values are deleted.**

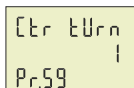

Figure-90

**Pr.59: Current Transformer Cable Turn Number**User defines the turn number, which is the number of how much tour the current cable has rounded into the current transformer. Numbers can be selected between 1-20. Greater the number of turn means greater the sensitivity

**Default:** 1, **Min:** 1, **Max:** 20.

### 13.6 - About:



Figure-31

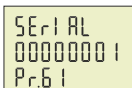

Figure-91

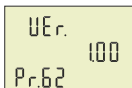

Figure-92

Press Menu button and enter password to enter program list. The figure-26(Voltage SET) is displayed when you enter password and press the Menu button.

The figure-27(Current SET) is displayed when you press the up button.

The figure-28(Frequency SET) is displayed when you press the up button.

The figure-29(RS485 SET) is displayed when you press the up button.

The figure-30(General SET) is displayed when you press the up button.

The figure-31(About) is displayed when you press the up button.

You enter "About" when you press Menu button. If you enter "About" menu, the figure-91(Pr.61) displayed. When you press the up button to see the other parameter on the display, the next data is displayed.

### 14- Enter Menu with Password:

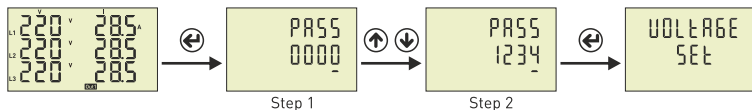

**Step 1:** Press "SET" button for entering menu.

**Step 2:** If Password is activated ,you can see "PASS" screen, you have to enter user password. There are four digit and press "Down" button ,selected digit is change. You can increase digit value using "Up" button. Press "Set" button after enter the user password. If you back to home screen you press "ESC"button. Default password is "0000".

## 15- Changing Password:

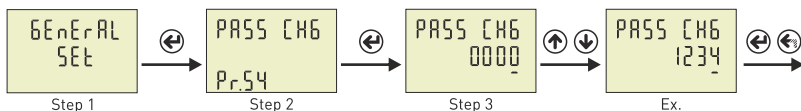

**Step 1:** Press Menu button and enter password to enter program list. The Voltage SET is displayed when you enter password and press the Menu button. Press "Up" button until you see the General SET

**Step 2:** Pr.54 is displayed when you press the "SET" button. Pr.54 is using for changing password. Pr.54 is deleted from screen when you press the "SET" button.

**Step 3:** You can change selected digit (underline) using "Down" button. "Up" button is used to increase its value. You can use "SET" button to save new password. If you press "ESC" button, you cannot record your settings.

## 16- Password Enable/Disable:

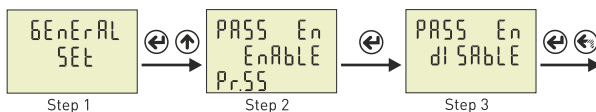

**Step 1:** Press Menu button and enter password to enter program list. The Voltage SET is displayed when you enter password and press the Menu button. Press "Up" button until you see the General SET

**Step 2:** Pr.54 is displayed when you press the "SET" button and press "Up" button. You will see Pr.55. It is used for enable/disable password protection. It is deleted from screen when you press the "SET" button.

**Step 3:** You can select Disable/Enable to use Up/Down Button. You can use "SET" button to save. If you press "ESC" button, you cannot record your settings.

## 17- High Voltage Protection Value Change:

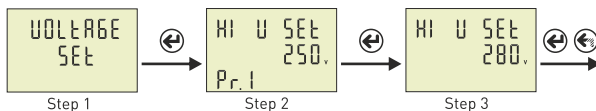

**Step 1:** Press Menu button and enter password to enter program list. The Voltage SET is displayed when you enter password and press the Menu button.

**Step 2:** Pr.1 is displayed when you press the "SET" button. It is used for setting high voltage protection value. It is deleted from screen when you press the "SET" button.

**Step 3:** You can increase/decrease value to use Up/Down Button. You can use "SET" button to save. If you press "ESC" button, you cannot record your settings.

## 18- Low Voltage Protection Value Change:

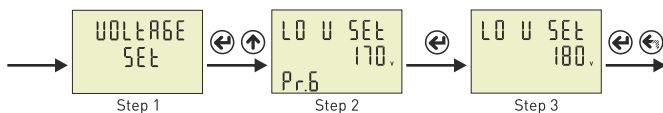

**Step 1:** Press Menu button and enter password to enter program list. The Voltage SET is displayed when you enter password and press the Menu button.

**Step 2:** Pr.1 is displayed when you press the "SET" button. and press "Up" button. You will see Pr.6. It is using for setting low voltage protection value. It is deleted from screen when you press the "SET" button.

**Step 3:** You can increase/decrease value to use Up/Down Button. You can use "SET" button to save. if you press "ESC" button, you cannot record your settings.

## 19- High Current Protection Value Change:



**Step 1:** Press Menu button and enter password to enter program list. The Voltage SET is displayed when you enter password and press the Menu button. Press "Up" button until you see the Current SET

**Step 2:** Pr.20 is displayed when you press the "SET" button. and press "Up" button. You will see Pr.20. It is using for setting high current protection value. It is deleted from screen when you press the "SET" button.

**Step 3:** You can increase/decrease value to use Up/Down Button. You can use "SET" button to save. if you press "ESC" button, you cannot record your settings.

## 20- Low Current Protection Value Change:

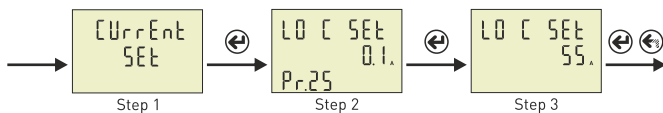

**Step 1:** Press Menu button and enter password to enter program list. The Voltage SET is displayed when you enter password and press the Menu button. Press "Up" button until you see the Current SET

**Step 2:** Pr.20 is displayed when you press the "SET" button. and press "Up" button. You will see Pr.25. It is using for setting low current protection value. It is deleted from screen when you press the "SET" button.

**Step 3:** You can increase/decrease value to use Up/Down Button. You can use "SET" button to save. if you press "ESC" button, you cannot record your settings.

## 21- Voltage Asymmetry Protection Value Change:

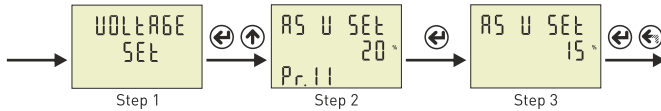

**Step 1:** Press Menu button and enter password to enter program list. The Voltage SET is displayed when you enter password and press the Menu button.

**Step 2:** Pr.1 (HI V SET) is displayed when you press the "SET" button and press "Up" button. You will see Pr.11. It is using for setting voltage asymmetry protection value. It is deleted from screen when you press the "SET" button.

**Step 3:** You can increase/decrease value to use Up/Down Button. You can use "SET" button to save. if you press "ESC" button, you cannot record your settings.

## 22- Phase Sequence Protection Enable/Disable:



**Step 1:** Press Menu button and enter password to enter program list. The Voltage SET is displayed when you enter password and press the Menu button. Press "Up" button until you see the General SET

**Step 2:** Pr.54 is displayed when you press the "SET" button and press "Up" button. You will see Pr.56. It is using for enable/disable phase sequence protection. It is deleted from screen when you press the "SET" button.

**Step 3:** You can select Disable/Enable to use Up/Down Button. You can use "SET" button to save. If you press "ESC" button, you cannot record your settings.

## 23- Demand Time Set:

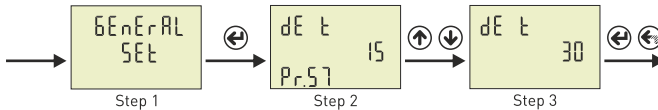

**Step 1:** Press Menu button and enter password to enter program list. The Voltage SET is displayed when you enter password and press the Menu button. Press "Up" button until you see the General SET

**Step 2:** Pr.54 is displayed when you press the "SET" button and press "Up" button. You will see Pr.57. It is using for setting demand time. It is deleted from screen when you press the "SET" button.

**Step 3:** You can increase/decrease value to use Up/Down Button. You can use "SET" button to save. If you press "ESC" button, you cannot record your settings.



This section describes some of the most commonly used parameters. You can adjust your system by apply them. These parameters are High/Low Voltage Protection value and hysteresis, Voltage Asymmetry protection value, High/Low Current Protection value and hysteresis, Current transformer ratio, demurrage factor and time.

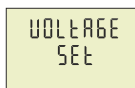

Press Menu button and enter password to enter program list. The Voltage SET is displayed when you enter password and press the Menu button. Voltage SET menu include set of high/low voltage protection and asymmetry settings. Pr.1 is displayed when you press the "SET" button.

Figure-26

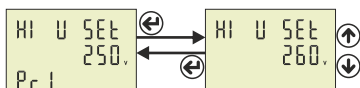

Figure-32

Pr.1 is using for setting high voltage protection. It is deleted from screen when you press the "SET" button. You can increase/decrease value to use Up/Down Button. You can use "SET" button to save. The figure-32 is displayed when you press the SET button. Press "Up" button until you see the Pr.4 (figure-35)

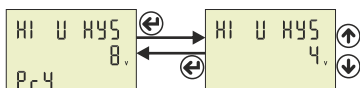

Figure-35

Pr.4 is using for setting high voltage protection hysteresis. It is deleted from screen when you press the "SET" button. You can increase/decrease value to use Up/Down Button. You can use "SET" button to save. The figure-35 is displayed when you press the SET button. Press "Up" button until you see the Pr.6 (figure-37)

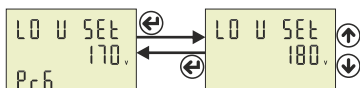

Figure-37

Pr.6 is using for setting low voltage protection. It is deleted from screen when you press the "SET" button. You can increase/decrease value to use Up/Down Button. You can use "SET" button to save. The figure-37 is displayed when you press the SET button. Press "Up" button until you see the Pr.9 (figure-40)

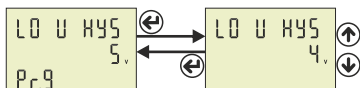

Figure-40

Pr.9 is using for setting low voltage protection hysteresis. It is deleted from screen when you press the "SET" button. You can increase/decrease value to use Up/Down Button. You can use "SET" button to save. The figure-40 is displayed when you press the SET button. Press "Up" button until you see the Pr.11 (figure-42)

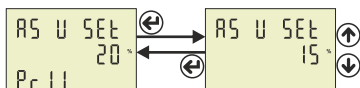

Figure-42

Pr.11 is using for setting voltage asymmetry protection. It is deleted from screen when you press the "SET" button. You can increase/decrease value to use Up/Down Button. You can use "SET" button to save. The figure-42 is displayed when you press the SET button. Press "ESC" button for back to main menu.

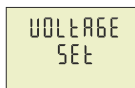
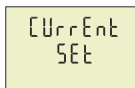

Figure-26

"Voltage SET" is displayed when you pressed the "ESC" button. (Figure-26)  
 "Current SET" is displayed when you press the "Up" button (Figure-27).



Current SET menu is include set of high/low current protection,current transformer ratio and demurrage settings.

Figure-27

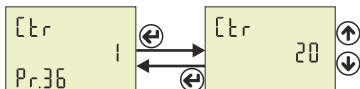

Figure-67



Pr.36 It is using for setting current transformer ratio\*. You can increase/decrease value to use Up/Down Button. You can use "SET" button to save. The figure-67 is displayed when you press the SET button. Press "Up" button until you see the Pr.25 (figure-56).

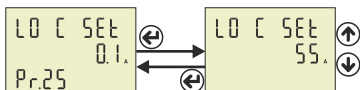

Figure-56



Pr.25 is using for setting low current protection. It is deleted from screen when you press the "SET" button. You can increase/decrease value to use Up/Down Button. You can use "SET" button to save. The figure-56 is displayed when you press the SET button. Press "Up" button until you see the Pr.20 (figure-51)

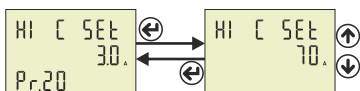

Figure-51



Pr.20 is displayed when you press the "SET" button and press "Up" button. You will see Pr.36 (Figure-67).It is using for setting current transformer ratio. You can increase/decrease value to use Up/Down Button. You can use "SET" button to save. The figure-67 is displayed when you press the SET button. Press "Up" button until you see the Pr.25 (figure-56).

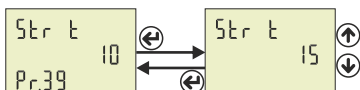

Figure-70



Pr.39 is using for setting demurrage time. It is deleted from screen when you press the "SET" button. You can increase/decrease value to use Up/Down Button. You can use "SET" button to save. The figure-70 is displayed when you press the SET button. Press "Up" button until you see the Pr.40 (figure-71).

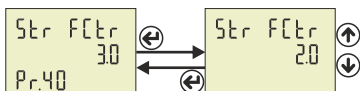
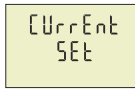

Figure-71



Pr.40 is using for setting demurrage time. It is deleted from screen when you press the "SET" button. You can increase/decrease value to use Up/Down Button. You can use "SET" button to save. The figure-71 is displayed when you press the SET button. Press twice "ESC" button for back to home screen.



All settings are made. Press ESC to exit. The figure-27 is displayed on screen. Press the ESC key again.

Figure-27



Home Screen

You have exited the menu. The "Home Screen" is displayed on screen. The device will control according to the set values.

## 25 - Parameters Table:

Menu	Parameter Number	Parameter	Unit	Default Value	Minimum Value	Maximum Value
VOLTAGE SET	Pr.1	High Voltage Value	Volt	250	1	300
	Pr.2	High Voltage Delay Time	Second	3	1	10000
	Pr.3	High Voltage Reset Time	Second	3	1	10000
	Pr.4	High Voltage Hysteresis	Volt	5	1	200
	Pr.5	High Voltage Protection	-	Disable	Disable	Enable
	Pr.6	Low Voltage Value	Volt	170	1	300
	Pr.7	Low Voltage Delay Time	Second	3	1	10000
	Pr.8	Low Voltage Reset Time	Second	3	1	10000
	Pr.9	Low Voltage Hysteresis	Volt	5	1	200
	Pr.10	Low Voltage Protection	-	Disable	Disable	Enable
	Pr.11	Voltage Asymmetry Value	-	%20	%5	%30
	Pr.12	Voltage Asymmetry Delay Time	Second	3	1	10000
	Pr.13	Voltage Asymmetry Reset Time	Second	3	1	10000
	Pr.14	Voltage Asymmetry Hysteresis	-	%2	%1	%10
	Pr.15	Voltage Asymmetry Protection	-	Disable	Disable	Enable
	Pr.16	Voltage Auto Reset	-	Disable	Disable	Enable
	Pr.17	Voltage Transformer Ratio	-	1	1	999
	Pr.18	Voltage Fuse	-	Disable	Disable	Enable
	Pr.19	Voltage Protection Type	-	L-n	L-n	L-L
CURRENT SET	Pr.20	High Current Value	Amper	3.0	0.1	5.0
	Pr.21	High Current Delay Time	Saniye	3	1	10000
	Pr.22	High Current Reset Time	Second	10	1	10000
	Pr.23	High Current Hysteresis	Amper	0.5	0.1	3.0
	Pr.24	High Current Protection	-	Disable	Disable	Enable
	Pr.25	Low Current Value	Amper	0.1	0.1	5.0
	Pr.26	Low Current Delay Time	Second	3	1	10000
	Pr.27	Low Current Reset Time	Second	10	1	10000
	Pr.28	Low Current Hysteresis	Amper	0.5	0.1	3.0
	Pr.29	Low Current Protection	-	Disable	Disable	Enable
	Pr.30	Current Asymmetry Value	-	%30	%5	%50
	Pr.31	Current Asymmetry Delay Time	Second	3	1	10000
	Pr.32	Current Asymmetry Reset Time	Second	10	1	10000
	Pr.33	Current Asymmetry Hysteresis	-	%3	%1	%20
	Pr.34	Current Asymmetry Protection	-	Disable	Disable	Enable
	Pr.35	Current Auto Reset	-	Disable	Disable	Enable
	Pr.36	Current Transformer Ratio*	-	1	1	2000
	Pr.37	Current Fuse	-	Disable	Disable	Enable
	Pr.38	Demurrage Protection	-	Disable	Disable	Enable
Pr.39	Demurrage Time	Second	10	1	100	
Pr.40	Demurrage Protection Factor	-	3.0	1.0	10.0	
FR EQ. SET	Pr.41	High Frequency Value	Hertz	51.0	45.0	70.0
	Pr.42	High Frequency Delay Time	Second	3	1	10000
	Pr.43	High Frequency Reset Time	Second	3	1	10000
	Pr.44	High Frequency Hysteresis	Hertz	0.5	0.1	20.0
	Pr.45	High Frequency Protection	-	Disable	Disable	Enable
	Pr.46	Low Frequency Value	Hertz	49.0	45.0	70.0
	Pr.47	Low Frequency Delay Time	Second	3	1	10000
	Pr.48	Low Frequency Reset Time	Second	3	1	10000
	Pr.49	Low Frequency Hysteresis	Hertz	0.5	0.1	20.0
	Pr.50	Low Frequency Protection	-	Disable	Disable	Enable
	Pr.51	Frequency Auto Reset	-	Disable	Disable	Enable
rS 485	Pr.52	ModBus ID	-	1	1	247
	Pr.53	ModBus BaudRate	bps	9600	1200	38400
GENERAL SET	Pr.54	Password Change	-	0000	0000	9999
	Pr.55	Password Protection	-	Disable	Disable	Enable
	Pr.56	Phase Sequence	-	Disable	Disable	Enable
	Pr.57	Demand Time	Minute	15	1	120
ABOUT	Pr.58	Demand Delete	-	-	-	-
	Pr.59	C.T. Cable Turn Number	Round	1	1	20
	Pr.60	Serial Number	-	-	-	-
	Pr.61	Version	-	-	-	-

\*: Only on EM-07

## 26 - Dimensions:

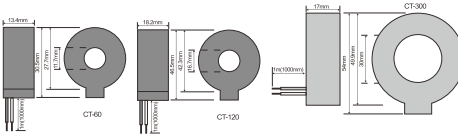
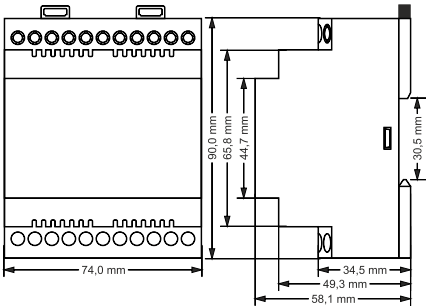

## 27 - Technical Specifications:

Operating Voltage	85V - 240V AC
Operating Frequency	50 / 60 Hz
Operating Power	<10VA
Operating Temperature	-20°C .....55°C
Voltage Input	5V -300V AC
Voltage Measurement Range	5V - 300kV
Current Input	50mA-5,5A(EM-07-DIN),1A-63A(EM-07-60D-DIN), 10A-100A(EM-07-100D-DIN),10A-250A(EM-07-250D-DIN)
Current Measurement Range	50mA-10.000A(EM-07-DIN),1A-63A(EM-07-60D-DIN), 10A-100A(EM-07-100D-DIN),10A-250A(EM-07-250D-DIN)
Voltage, Current Accuracy	%±1
Supported Connection	3P4W
Current Transformer Ratio	1....2000(Only on EM-07-DIN)
Voltage Transformer Ratio	1....999
Communication	RS485 MODBUS RTU
Display	53 x 31 mm Glass LCD
Output	2A / 250V AC (Resistive Load)
Weight	<300Gr.
Protection Class	IP20
Panel Hole Size	91mm x 91mm
Connection Type	Plug-in Connection
Cable Diameter	1.5mm <sup>2</sup>
Installation	Assembled on the din rail
Operating Altitude	<2000meters

## 28 - Index:

Subject:	Page
1 - Connections Diagrams:	1
2 - Points to take into consideration in the selection and connection of Current Transformer:	2
3 - Warnings:	2
4 - Maintenance of the Device:	2
5 - General:	2
6 - Introduction of Home Screen:	3
7 - Definition of Buttons:	3
8 - Error Codes:	4
9 - Start-up of the Device:	4
10 - Display Information:	4
11 - To advance in Display Inventory:	6
12 - Settings:	6
13.1 - Voltage Settings:	7
13.2 - Current Settings:	10
13.3 - Frequency Settings:	13
13.4 - RS485 Settings:	15
13.5 - General Settings:	15
13.6 - About:	16
14 - Enter Menu with Password:	16
15 - Changing Password:	17
16 - Password Enable/Disable:	17
17- High Voltage Protection Value Change:	17
18 - Low Voltage Protection Value Change:	18
19 - High Current Protection Value Change:	18
20 - Low Current Protection Value Change:	18
21 - Voltage Asymmetry Protection Value Change:	19
22 - Phase Sequence Protection Enable/Disable:	19
23 - Demand Time Set:	19
24 - Quick Setup:	20
25 - Parameters Table:	22
26 - Dimensions:	23
27 - Technical Specifications:	23
28 - Index:	23
29 - Contact:	23