EM-07E-DIN and EM-07E-60D,EM-07E-100D,EM-07E-250D USER MANUAL



- * Rs485 Modbus RTU (1200 - 38400bps)
- * 53 x 31 Custom Design Glass LCD
- * 3-phase voltage and 3-phase current transformer.
- * It shows that V1,V2,V3 , V12, V23, V31, I1,I2, I3, S1,S2, S3, F1,F2, F3
- * It shows the minimum, maximum and average values of V1,V2,V3,V12,V23,V31,F1,F2, F3
- * It shows the minimum, maximum, average and demand values of I1,I2, I3, S1,S2, S3
- * Shows phase sequence
- * You can delete the demands
- * Menu is password-protected.

1 - Connection Diagrams:

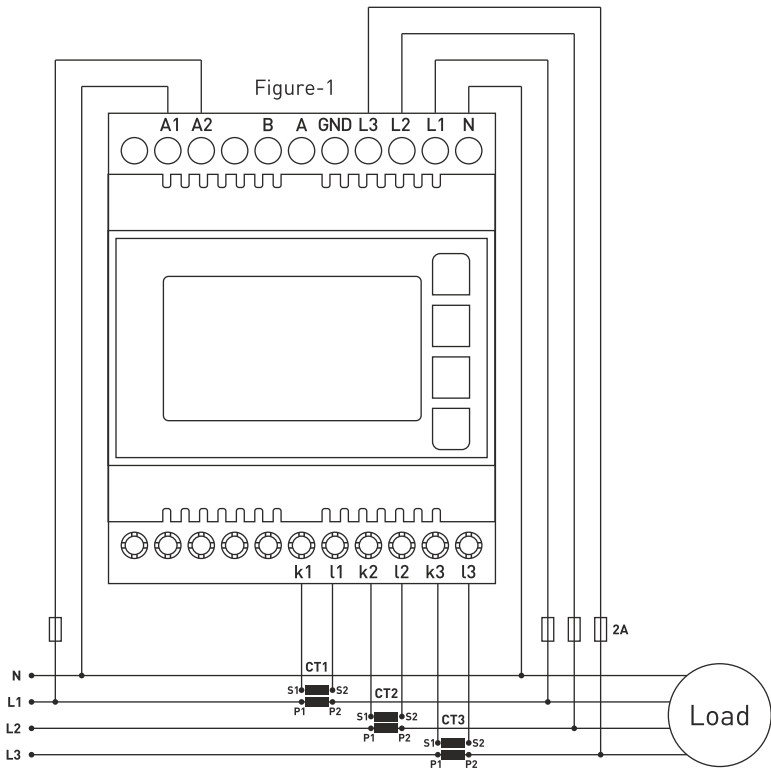

Figure-1: 3P4W connection type: 3 phase current and 3 phase voltage and neutral.

2 - Points to take into consideration in the selection and connection of Current Transformer: _____

- Be sure that the current transformer value is higher than the maximum current drawn from the system.
- In order to prevent any mistake while connecting the output terminals of the current transformer, use cables in different colors for each phase or designate a number for each cable.
- Keep the cables connected to the output terminals of the current transformer away from the high-voltage line.
- In order to prevent any shake on the current transformer, fix it on the bus-bar, cable or rail.

3 - Warnings: _____

- Use the device according to the instructions specified by us.
- Do not expose the LCD display directly to sunlight in order to avoid any harm on it.
- Note that the temperature level on the panel to which the device is mounted is at the range of operating temperature of the device (-20°C.....55°C)
- There must be a space of 5cm behind the device after its installation.
- Fix the device securely to the front-cover of the panel with the apparatus delivered together with the device.
- Be sure that the panel to which the device is mounted does not operate in a humid environment.
- Place the switch or circuit breaker close to the device or in a location that is easily accessible for the operator.
- Place a switch or circuit breaker on the system during installation of the device.
- Please note that the cables must not be energized during installation.
- Flexible monitored and twisted cables must be used for the input and output lines which are not connected to the mains.
- The technical personnel according with the instructions specified in the user's manual must perform installation of the device and electrical connections.
- The feeder cables must be compatible with the requirements of IEC 60227 or IEC 60245

4 - Maintenance of the Device: _____

De-energize and disconnect the device. Clean the body of the device with a dry or damp-dry cloth. Do not use conductive or other chemical substances as a cleaning agent that can damage the device. After cleaning the device, make its connections and check whether it is working by energizing it.

5 - General: _____



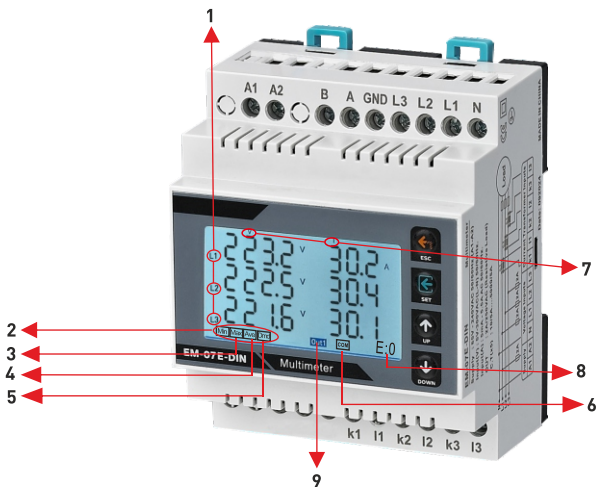

EM-07E-DIN Multimeter measures the load on the system and voltage, current, apparent power minimum and maximum values, demands related to this load on the system.

6- Introduction of Home Screen:



- 1 - It shows phase number belong to measurement values
- 2 - Showing values are minimum of measurement values
- 3 - Showing values are maximum of measurement values
- 4 - Showing values are average of measurement values
- 5 - Showing values are demand of measurement values
- 6 - It shows Serial Communications
- 7 - It shows that type of measurement values
- 8 - It shows number of error

7- Definition of Buttons:

-  **ESC:** State of Measurement; Back to home screen. State of Menu; Exit menu. State of changing parameter; Not save chance and back to menu state.
-  **SET:** State of Measurement; Entry Menu. State of Menu; Entry state of changing parameter. State of changing parameter; save chance and back to menu state
-  **UP:** State of Measurement; To navigate from a main measurement values to another. State of Menu; To navigate from menu parameters to another. State of changing parameter; Increase value of parameter
-  **DOWN:** State of Measurement; To navigate from a deep measurement values to another (min,max,avg, dmd). State of Menu; To navigate from menu parameters to another. State of changing parameter; Decrease value of parameter

8 - Start-up of the Device :

Read the warnings before the device is energized. Make sure that the device is connected according to the connection diagram. When the device is energized for the first time, the Home Screen is displayed. Enter the current transformer ratio and the voltage transformer ratios, if installed, on the settings menu at first.

9 - Display Information :



Home Screen



Figure-3



Figure-4



Figure-5



Figure-6

Home Screen: It shows voltage and current values together. If protection type is L-N, it shows phase-neutral voltage else, if protection type is L-L it shows phase-phase voltage. If you use voltage transformer, it is not showed. The figure-3 is displayed when you press the Down button.

Figure-3: It shows the phase-neutral voltage values. The figure-4 is displayed when you press the Down button.

Figure-4: It shows the phase-neutral minimum voltage values. The figure-5 is displayed when you press the Down button.

Figure-5: It shows the phase-neutral maximum voltage values. The figure-6 is displayed when you press the Down button.

Figure-6: It shows the phase-neutral mean voltage values. The figure-7 is displayed when you press the Down button.



Figure-7



Figure-8



Figure-9



Figure-10

Figure-7: It shows the phase- phase voltage values. The figure-8 is displayed when you press the Down button.

Figure-8: It shows the phase- phase minimum voltage values. The figure-9 is displayed when you press the Down button.

Figure-9: It shows the phase- phase maximum voltage values. The figure-10 is displayed when you press the Down button.

Figure-10: It shows the phase- phase mean voltage values. The figure-11 is displayed when you press the Down button.



Figure-11



Figure-12



Figure-13



Figure-14



Figure-15

Figure-11: It shows the current values of each phase. The figure-12 is displayed when you press the Down button.

Figure-12: It shows the minimum current values of each phase. The figure-13 is displayed when you press the Down button.

Figure-13: It shows the maximum current values of each phase. The figure-14 is displayed when you press the Down button.

Figure-14: It shows the mean current values of each phase. The figure-15 is displayed when you press the Down button.

Figure-15: It shows the current demand current values of each phase. The figure-16 is displayed when you press the Down button.



Figure-16



Figure-17



Figure-18



Figure-19

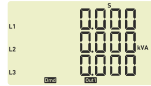

Figure-20

Figure-16: It shows the apparent power values of each phase. The figure-17 is displayed when you press the Down button.

Figure-17: It shows the minimum apparent power values of each phase. The figure-18 is displayed when you press the Down button.

Figure-18: It shows the maximum apparent power values of each phase. The figure-19 is displayed when you press the Down button.

Figure-19: It shows the mean apparent power values of each phase. The figure-20 is displayed when you press the Down button.

Figure-20: It shows the apparent power demand values of each phase. The figure-21 is displayed when you press the Down button.



Figure-21



Figure-22



Figure-23



Figure-24

Figure-21: It shows the frequency values of each phase. The figure-22 is displayed when you press the Down button.

Figure-22: It shows the minimum frequency values of each phase. The figure-23 is displayed when you press the Down button.

Figure-23: It shows the maximum frequency values of each phase. The figure-24 is displayed when you press the Down button.

Figure-24: It shows the mean frequency values of each phase. The Home Screen is displayed when you press the Down button.

10- To advance in Display Inventory:

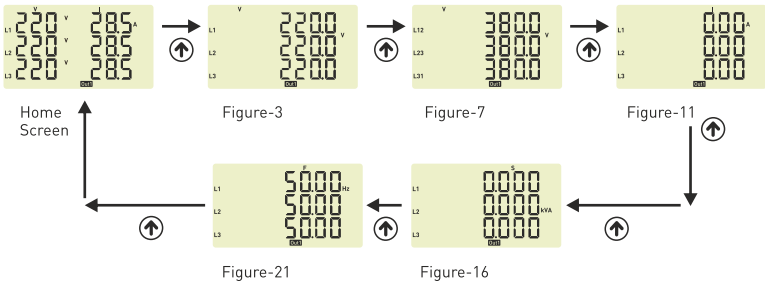

The Home screen is displayed, when the device is energized. When you press the up button to see the other data on the display, the next data is displayed (Figure-3). The figure-7 is displayed when you press the Up button. The figure-11 is displayed when you press the Up button. The figure-16 is displayed when you press the Up button. The figure-21 is displayed when you press the Up button. The screen back to Home Screen when you press the Up button.

If you want to see values of min, max, mean and demand you can use down button. If you back to home screen in anywhere, you can use ESC button.

11 - Menu Structure:

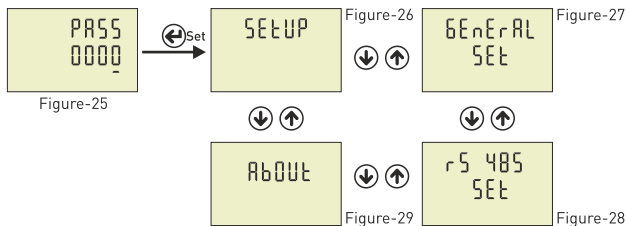

Figure-25: Press Menu button to enter password section. The figure-25 is displayed when you enter password and press the Menu button.

Figure-26: It uses for setup settings. The figure-27 is displayed when you press the UP button.

Figure-27: It uses for general settings. The figure-28 is displayed when you press the UP button.

Figure-28: It uses for RS485 settings. The figure-29 is displayed when you press the UP button.

Figure-29: It uses for about the device. This section give a information about device serial number and version number. You can use ESC button for exit menu.

11.1 - Setup Settings:

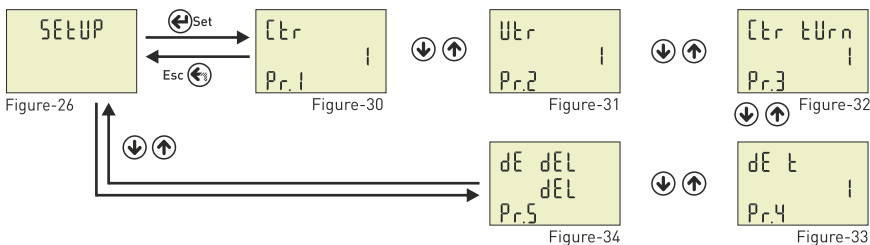

Press Menu button and enter password (Default Password =0000) to enter program list. The figure-26 is displayed when you enter password and press the Menu button. By using up-down buttons select the program.

Press Menu to enter required program. By up-down buttons, you can set the program. Press Menu to record your settings, if you press ESC button, you cannot record your settings.

- Pr.1: Current Transformer Ratio (EM-07E-60D, 100D, 250D-DIN disabled)
- Pr.2: Voltage Transformer Ratio
- Pr.3: Current Transformer Cable Turn Number
- Pr.4: Demand Time
- Pr.5: Demand Delete

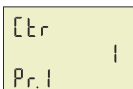

Figure-30

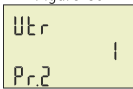

Figure-31

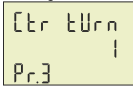

Figure-32

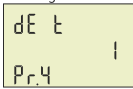

Figure-33

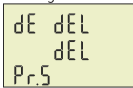

Figure-34

Pr.1: Current Transformer Ratio : If a current transformer which has a ratio of 100/5A is used between the system and device; Current transformer ratio is entered as = $100/5 = 20$. If the current transformer is not used between the system and device, current transformer ratio is entered as "1"
Default: 1, Min: 1, Max: 2000

Pr.2: Voltage Transformer Ratio : If you use medium voltage , you can use VTR
Default: 1, Min: 1, Max: 999

Pr.3: Current Transformer Cable Turn Number: User defines the turn number, which is the number of how much tour the current cable has rounded into the current transformer. Numbers can be selected between 1-20. Greater the number of turn means greater the sensitivity
Default: 1, Min: 1, Max: 20.

Pr.4: Demand Time: Determines demand calculate time. Demand is calculated using average value. Device take sample for demand time and calculate average value. Demand is maximum average value.
Default: 15min, Min: 1min, Max: 120min.

Pr.5: Demand Record Delete: You can delete demand and average records.

11.2 - General Settings:

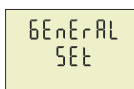

Figure-27

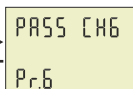

Figure-35

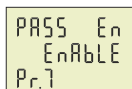

Figure-36

Press Menu button and enter password to enter program list. The figure-26 (Setup Settings) is displayed when you enter password and press the Menu button. The figure-27 (General Settings) is displayed when you press the up button. You enter General set when you press Menu button. If you enter General set menu, the figure-35 (Pr.6) displayed.

This menu have 2 different current set value. When you press the up button to see the other General set values on the display, the next data is displayed. By using up-down buttons select the program. Press Menu to enter required program. By up-down buttons, you can set the program. Press Menu to record your settings, if you press ESC button, you cannot record your settings.

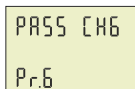

Figure-35

Pr.6: Password Chan ge: This menu is used for changing the user password.
Default: 0000, Min: 0000, Max: 9999

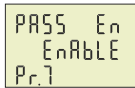
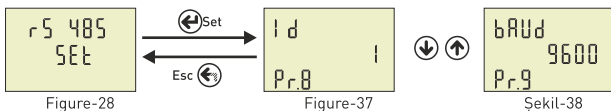

Figure-36

Pr.7: Password Protection Enable/Disable: This menu is used for activating the user password. After the user password is activated for entering to the menus; if the Menu button is pressed, while the instant values are observed, user password is required.
Default: Disable, Min: Disable, Max: Enable

11.3 - RS485 RS485 Settings:



Press Menu button and enter password to enter program list. The figure-26(Setup Settings) is displayed when you enter password and press the Menu button. The figure-27 (General Settings) is displayed when you press the up button. The figure-28 (RS-485 Settings) is displayed when you press the up button. You enter RS-485 set when you press Menu button.

If you enter Rs-485 set menu, the figure-37(Pr.8) displayed. This menu have 2 different set value. When you press the up button to see the other RS485 set value on the display, the next data is displayed. By using up-down buttons select the program. Press Menu to enter required program. By up-down buttons, you can set the program. Press Menu to record your settings, if you press ESC button, you cannot record your settings.

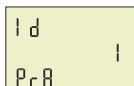

Figure-37

Pr.8: Modbus ID: Determines Modbus device ID.
Default: 1, Min: 1, Max: 247

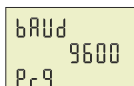

Figure-38

Pr.9: Baudrate: Determines Modbus communication speed.
Default: 9600bps, Min: 1200bps, Max: 38400bps

Note: Stopbits: 1, Parity: none and Databits:8

11.4 - About the Device



Figure-29

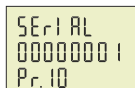

Figure-39

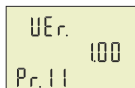

Figure-40

Press Menu button and enter password to enter program list. The figure-26 (Setup Settings) is displayed when you enter password and press the Menu button.

The figure-27 (General Settings) is displayed when you press the up button.

The figure-28(About the Device) is displayed when you press the up button.

You enter "About" when you press Menu button. If you enter "About" menu, the figure- 39 (Pr.10) displayed. When you press the up button to see the other parameter on the display, the next data is displayed.

12- Enter Menu with Password :

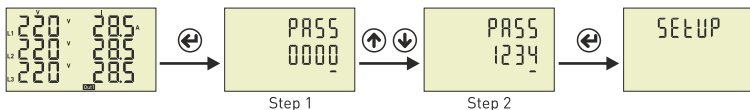

Step 1: Press "SET" button for entering menu.

Step 2: If Password is activated, you can see "PASS" screen, you have to enter user password. There are four digit and press "Down" button, selected digit is change. You can increase digit value using "Up" button. Press "Set" button after enter the user password. If you back to home screen you press "ESC" button. Default password is "0000".

13- Changing Password:

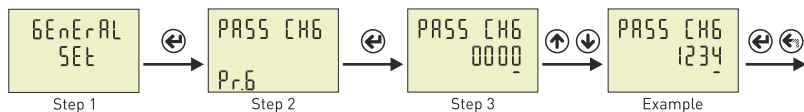

Step 1: Press Menu button and enter password to enter program list. The Voltage SET is displayed when you enter password and press the Menu button. Press "Up" button until you see the General SET

Step 2: Pr.54 is displayed when you press the "SET" button. Pr.1 is using for changing password. Pr.6 is deleted from screen when you press the "SET" button.

Step 3: You can change selected digit (underline) using "Down" button. "Up" button is used to increase its value. You can use "SET" button to save new password. If you press "ESC" button, you cannot record your settings.

14- Password Enable/Disable:

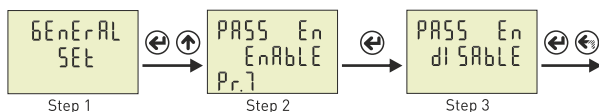

Step 1: Press Menu button and enter password to enter program list. The Voltage SET is displayed when you enter password and press the Menu button. Press "Up" button until you see the General SET

Step 2: Pr.1 is displayed when you press the "SET" button and press "Up" button. You will see Pr.7. It is using for enable/disable password protection. It is deleted from screen when you press the "SET" button.

Step 3: You can select Disable/Enable to use Up/Down Button. You can use "SET" button to save. If you press "ESC" button, you cannot record your settings.

15- Demand Time Set:

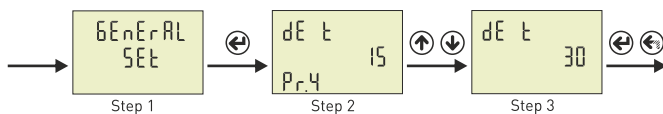

Step 1: Press Menu button and enter password to enter program list. The Voltage SET is displayed when you enter password and press the Menu button. Press "Up" button until you see the General SET

Step 2: Pr.1 is displayed when you press the "SET" button and press "Up" button. You will see Pr.4. It is using for setting demand time. It is deleted from screen when you press the "SET" button.

Step 3: You can increase/decrease value to use Up/Down Button. You can use "SET" button to save. If you press "ESC" button, you cannot record your settings.

16 - Parameters Table:

Menu	Parameter Number	Parameter	Unit	Default Value	Minimum Value	Maximum Value
SETUP	Pr.1	Current Transformer Ratio	-	1	1	2000
	Pr.2	Voltage Transformer Ratio	-	1	1	999
	Pr.3	C.T Cable Turn Number	Round	1	1	20
	Pr.4	Demand Time	Minute	15	1	120
	Pr.5	Demand Delete	-	-	-	-
GENERAL SET	Pr.6	Password Change	-	0000	0000	9999
	Pr.7	Password Protection	-	Passive	Passive	Active
RS 485	Pr.8	ModBus ID	-	1	1	247
	Pr.9	ModBus BaudRate	bps	9600	1200	38400
ABOUT	Pr.10	Serial Number	-	-	-	-
	Pr.11	Version	-	-	-	-

17 - Dimensions:

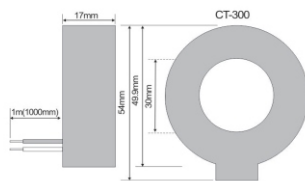
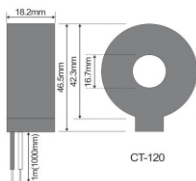
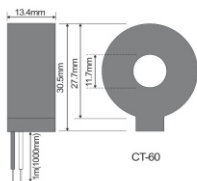
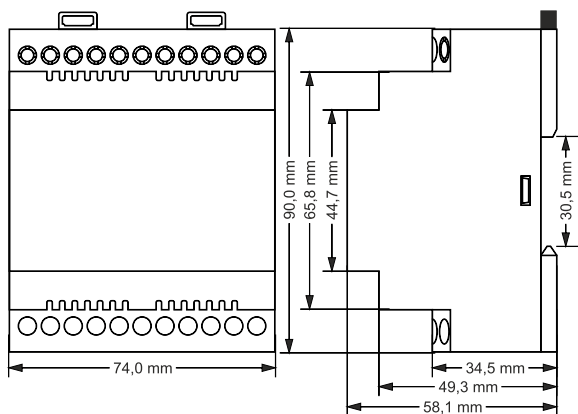

18 - Technical Specifications: 19 - Index:

Operating Voltage	85V - 240V AC
Operating Frequency	50 / 60 Hz
Operating Power	<10VA
Operating Temperature	-20°C55°C
Voltage Input	5V -300V AC
Voltage Meas. Range	5V - 300kV
Current Input	50mA-5,5A[EM-07E-DIN],1A-63A[EM-07E-60D-DIN], 10A-100A[EM-07E-100D-DIN],10A-250A[EM-07E-250D-DIN]
Current Meas. Range	50mA-10.000A[EM-07E-DIN],1A-63A[EM-07E-60D-DIN], 10A-100A[EM-07E-100D-DIN],10A-250A[EM-07E-250D-DIN]
Voltage, Current Accuracy	% ±1
Supported Connection	3P4W
Current Transformer Ratio	1.....2000 [EM-07E-DIN]
Voltage Transformer Ratio	1....999
Communication	RS485 MODBUS RTU
Display	53 X 31mm Glass LCD
Weight	<300Gr.
Protection Class	IP20
Connection Type	Plug-in Connection
Cable Diameter	1.5mm ²
Installation	Assembled on the Din Rail
Operating Altitude	<2000meters

Subject:	Page
1 - Connections Diagrams:	1
2 - Points to take into consideration in the selection and connection of Current Transformer:	2
3 - Warnings:	2
4 - Maintenance of the Device:	2
5 - General:	2
6 - Introduction of Home Screen:	3
7 - Definition of Buttons:	3
8 - Start-up of the Device:	4
9 - Display Information:	4
10 - To advance in Display Inventory:	5
11- Menu Structure	6
11.1 - Setup Settings:	6
11.2 - General Ayarlar:	7
11.3 - RS485 Communication Settings:	8
11.4 - About the Device:	8
12 - Enter Menu with Password:	8
13 - Changing Password:	9
14 - Password Enable/Disable:	9
15 - Demand Time Set:	9
16 - Parameters Table:	10
17 - Dimensions:	10
18 - Technical Specifications:	11
19 - Index:	11
20 - Contact:	11